

# Strojník

Hair straightener



Eva Holešová

2025/26

Forma nasleduje funkciu

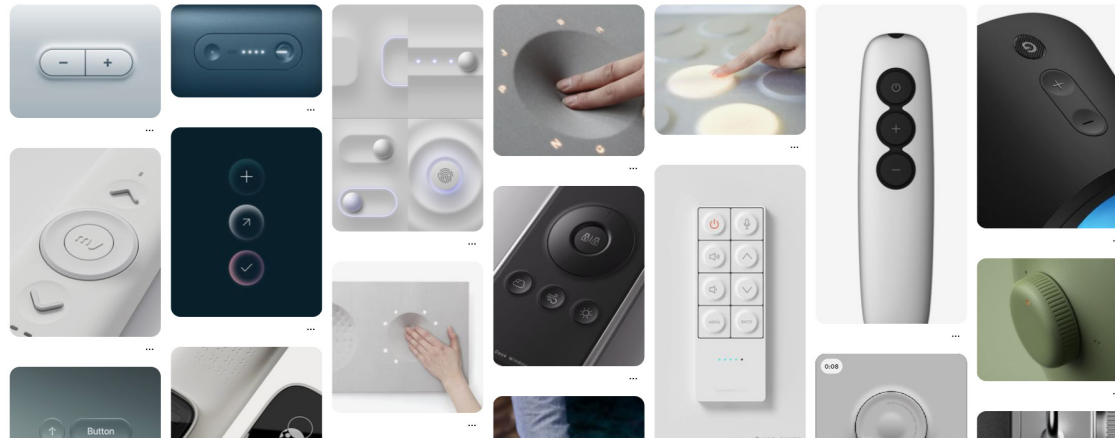
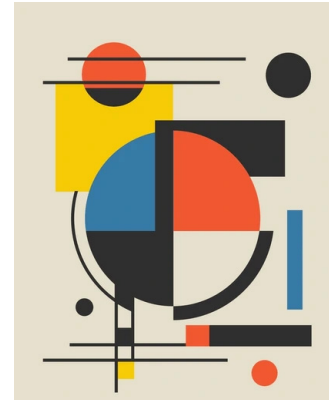
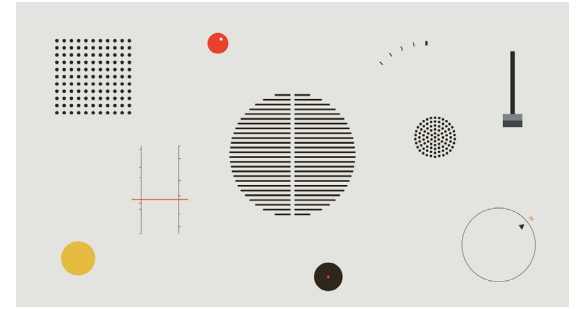

1  
INŠPIRÁCIE

# 2.

## NÁVRHOVÁ ČASŤ

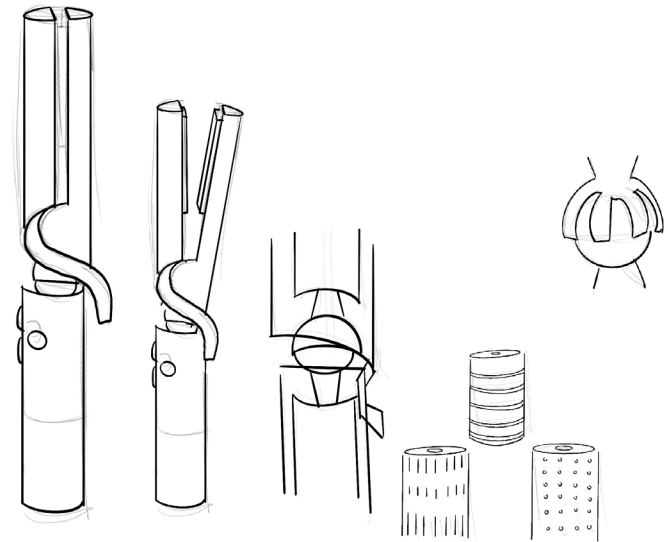
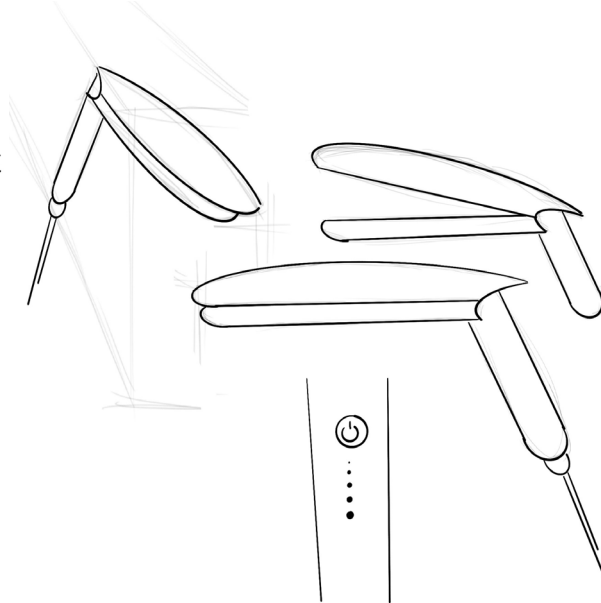
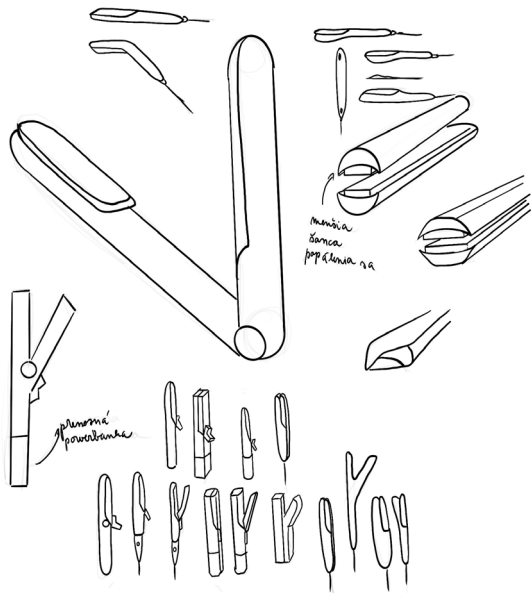
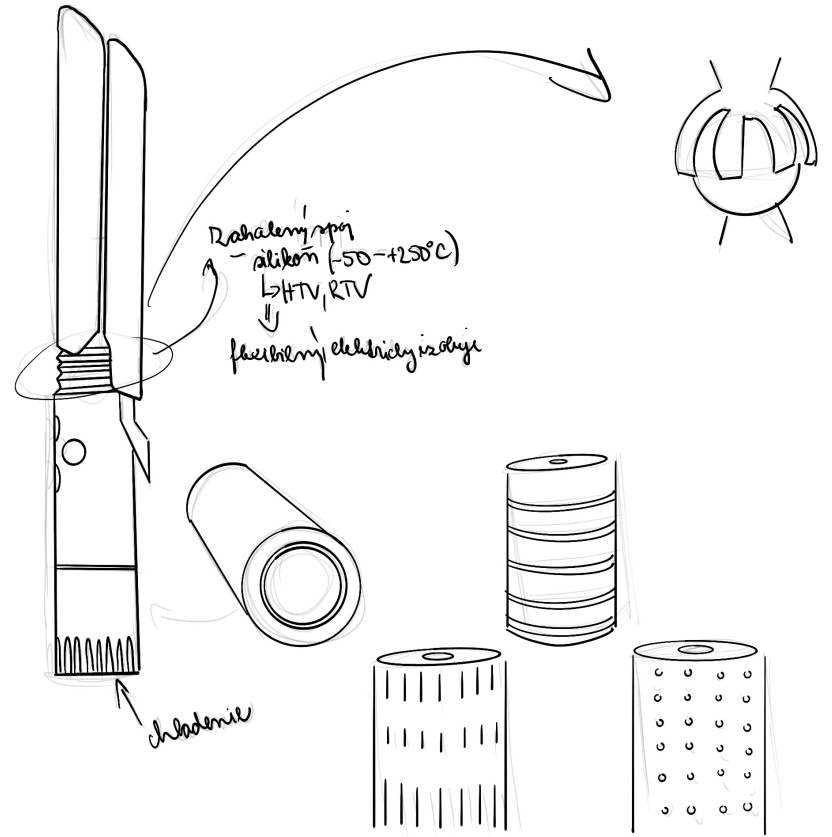
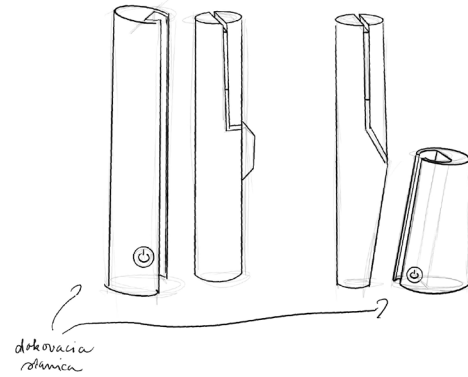

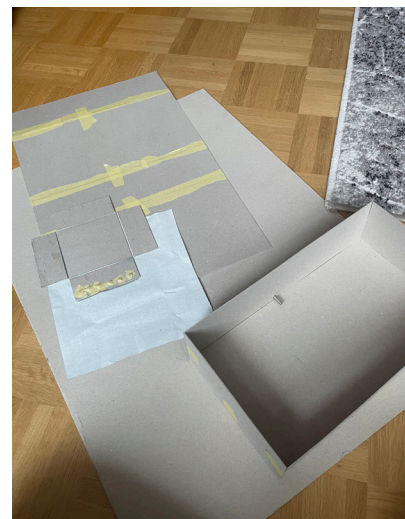
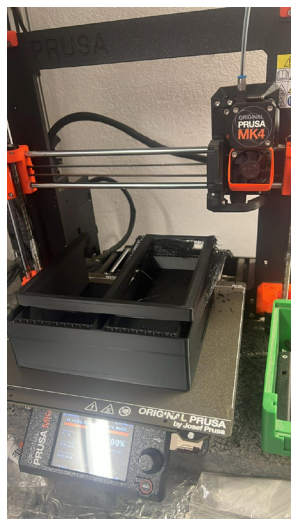
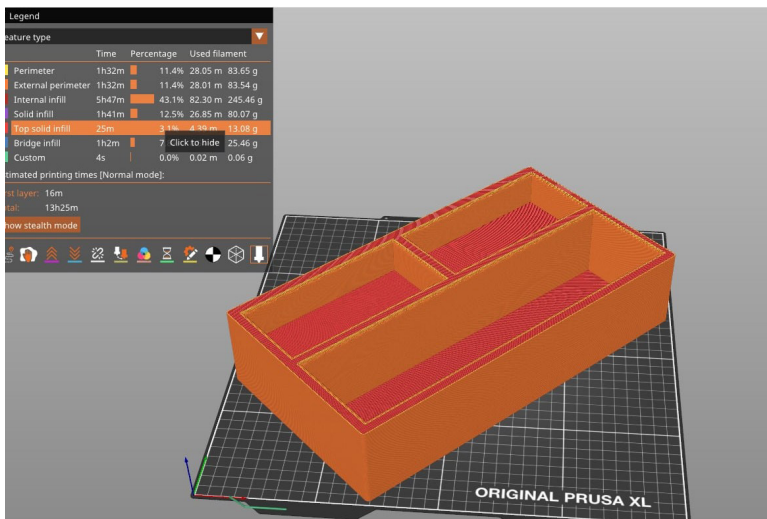
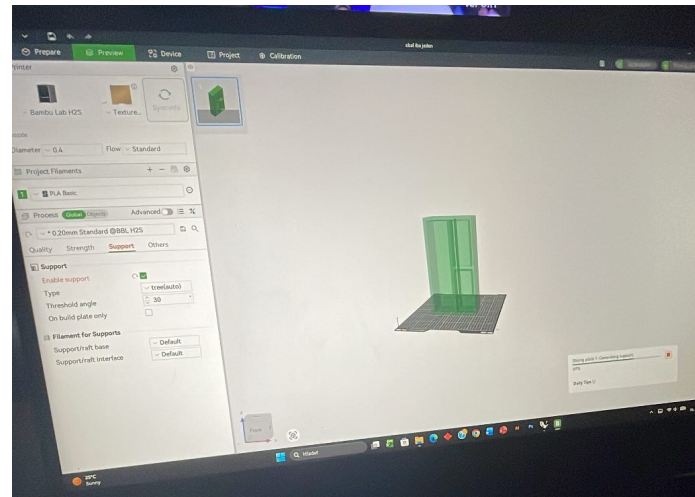
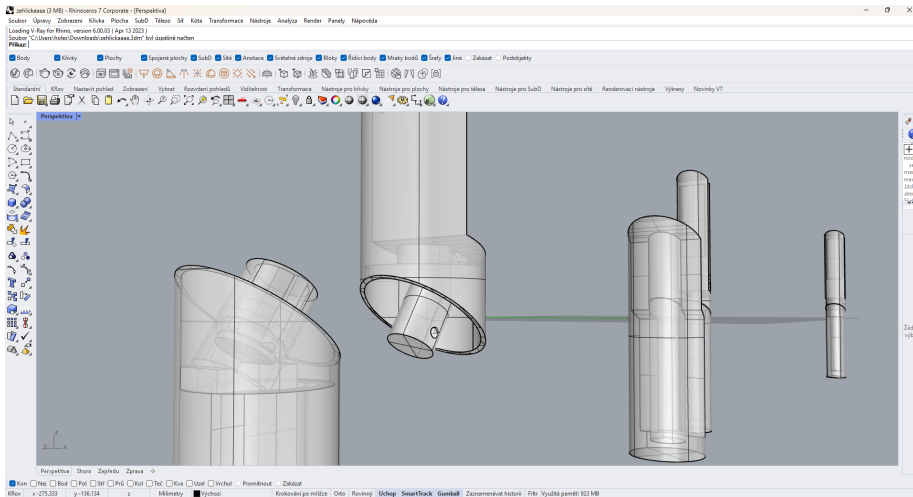
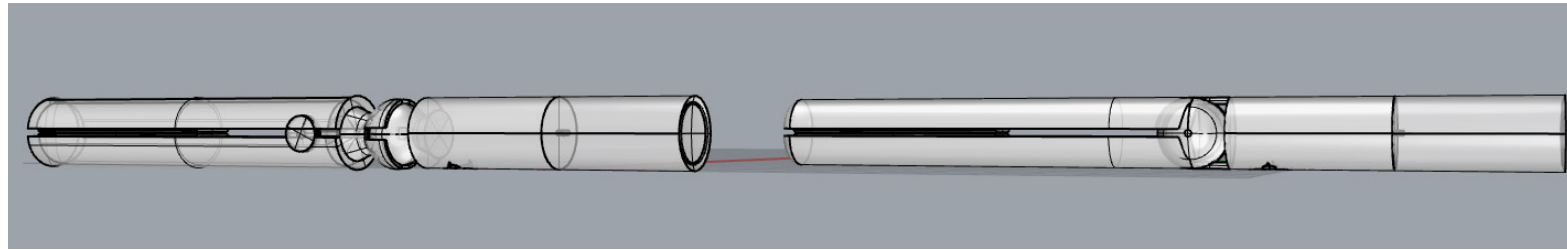

# 3.

## POSTUP PRÁCE

# 4.

## VIZUALIZÁCIE



VŠETKY FOTKY POUŽITÉ NA TOMTO SLIDE SÚ VYTVROENÉ POMOCOU AI

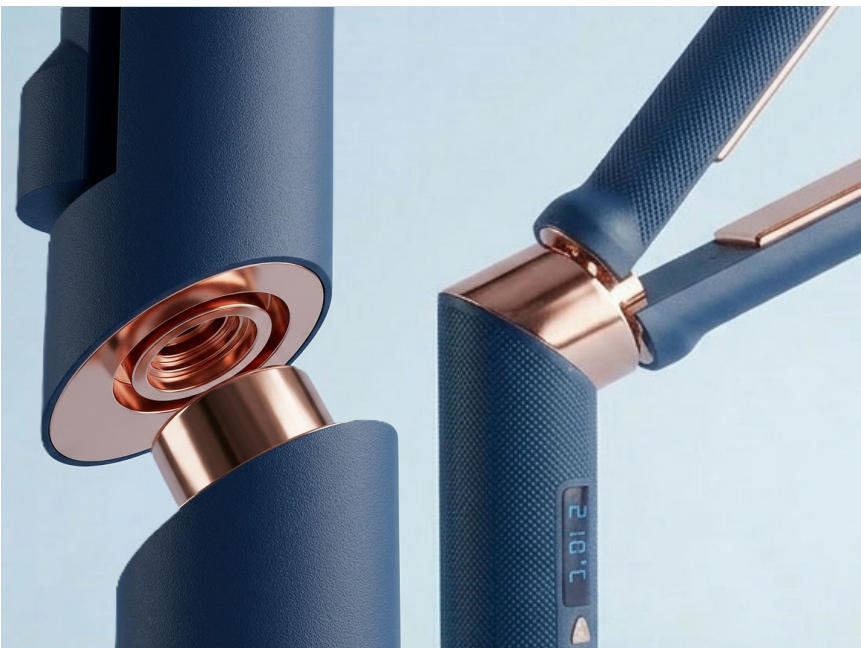

Rotovacia rukoväť



Nabíjateľná žehlička pomocou dokovacej stanice

Ľahšie otváranie vďaka klíbkom, ktoré otáčajú iba jednu časť.



5.  
VYCHYTÁVKY OBJEKTU

# 6

## NABÍJANIE ŽEHLIČKY

Napájací adaptér 12,6 V / 2 A

Nabíjacia stanica  
s magnetickými kontaktmi

Systém správy batérie (BMS)

Batériový pack 3S Li-ion (3 články v sérii)

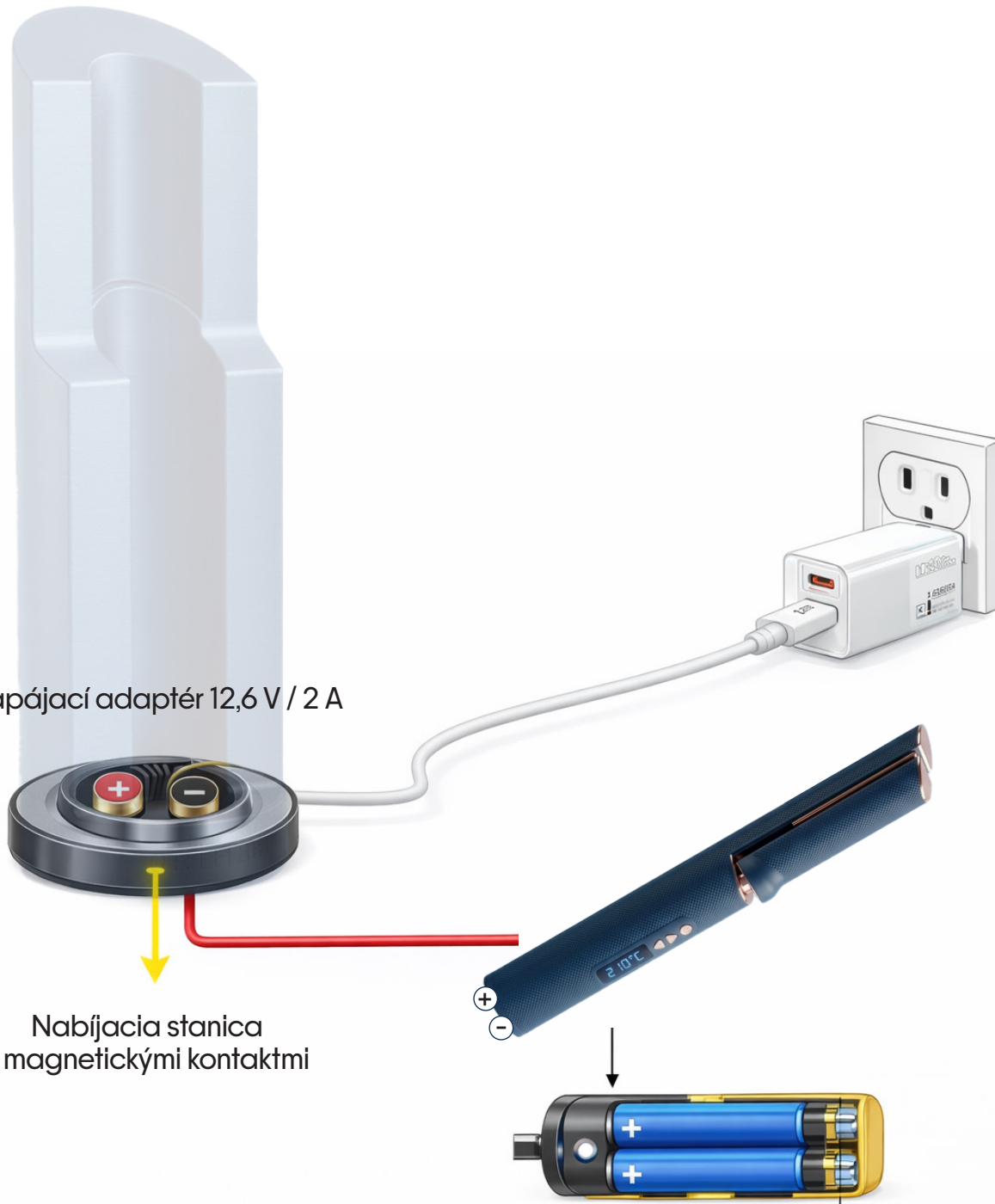

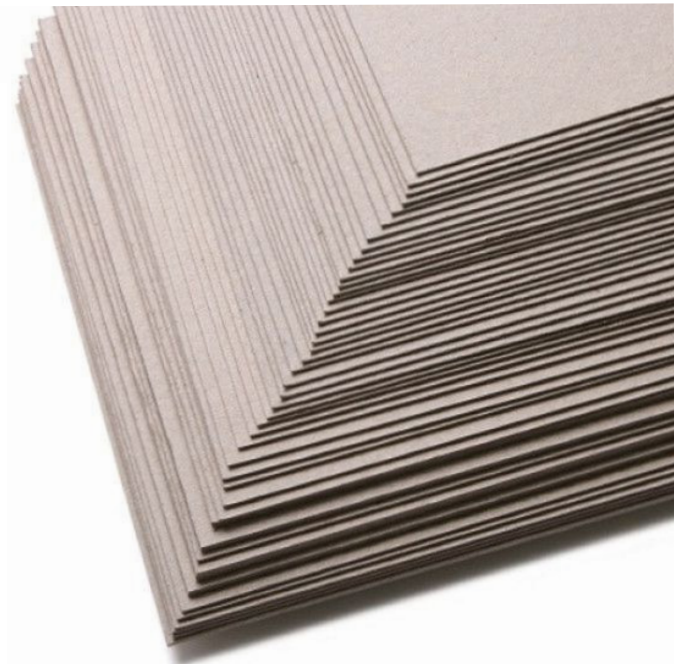
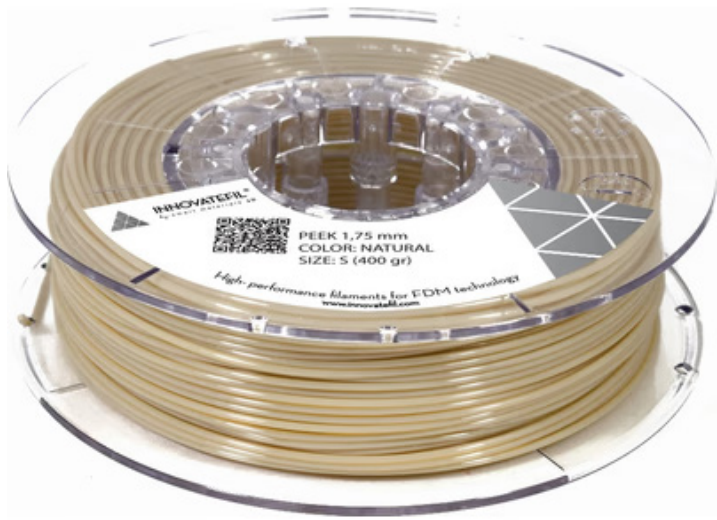

# 7

## MATERIÁLY

POLOŽKA	POČET	JEDNOTKOVÁ CENA	SPOLU	POZNÁMKA
<i>MATERIÁL</i>				
PEEK filament	1	210,00	210,00	400g filamentu
Titánové platne	1	50,99	50,99	500mmx300mmx0,5mm
Batéria 21700	3	6,95	20,85	Článok
3S BMS modul	1	15,00	15,00	
12,6V nabíjačka	1	20,00	20,00	
Cena za materiál celkom			302,94	
<i>PREVÁDZKOVÉ NÁKLADY A CENA PRÁCE</i>				
	125 HODÍN	15,00	1875,00	Hodiny v škole
Hodinová mzda	1XA2 2XA4	7,50+0,50	8,50	
Cena tlače		850,00	850,00	
Služby				
Prevádzkové náklady celkom			2733,50	
<i>Finálny rozpočet reálneho produktu</i>			3036,44	

8

ROZPOČET PRODUKTU

## PROTOTYP

### *MATERIÁL*

PETG FILAMENT	1	25,00	25,00	1000g filamentu
Hliníková platňa	1	15,00	15,00	
Zips	1	1,00	1,00	40cm
Látka	1	1,50	40,00	20cmx100cm
Nálepky	3	5,00	15,00	3xA4

Cena za materiál celkom

### *PREVÁDZKOVÉ NÁKLADY A CENA PRÁCE*

	125 HODÍN	15,00	1875,00	Hodiny v škole
Hodinová mzda	1XA2 2XA4	7,50+0,50	8,50	
Cena tlače		850,00	850,00	
Služby				

Prevádzkové náklady celkom

2733,50

*Finálny rozpočet prototypu*

2773,50

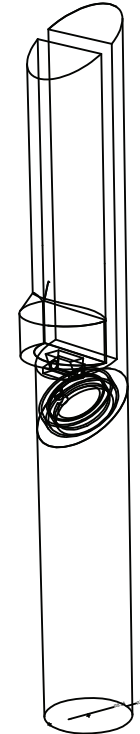
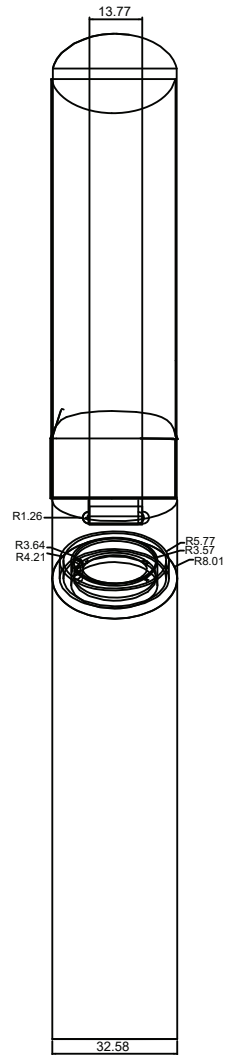
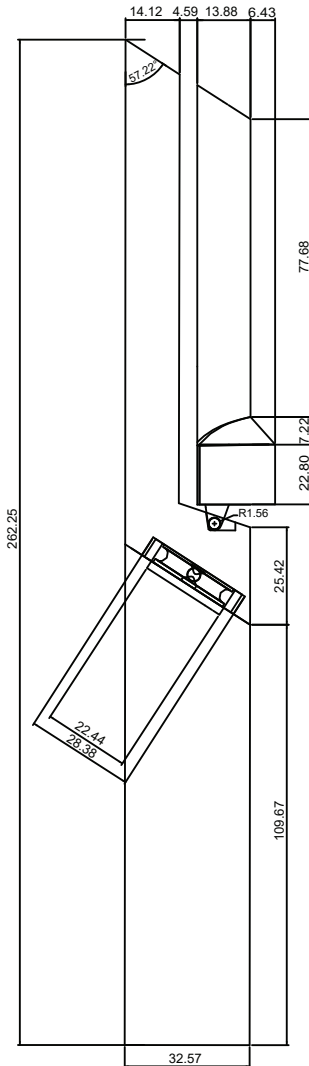
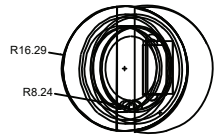

METÓDA ZOBRAZOVANIA 	MIERKA 1:2	SYMBOL — — —	ZMENA — — —	DÁTUM — — —	POPIS — — —
POZNÁMKA	VŠEOBECNÉ TOLERANCIE	ČÍSLO VÝKRESU ZOSTAVY ČÍSLO SÚPSISU POLOŽIEK			
MATERIÁL	3D tlač	SÚKROMNÁ ŠKOLA UMELECKÉHO PRIEMYSLU ŽILINA			
ROZMER	262,25x32,57x32,57				
HR. HMOTNOSŤ	90 g	NÁZOV STRAIGHT			
ŠTUDIJNÁ SKUPINA	4.B	ČÍSLO VÝKRESU STR-2-8603 M			
VYPRACOVAL	EVA HOLEŠOVÁ				
PREKontroloval					
DÁTUM VYHOTOVENIA 1.4.2026	ROZMER VÝKR. LISTU ISO-A3				

# stroi

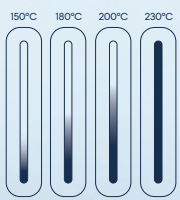

20-40 min

150-230°C

vhodné pre kučeravé vlasy  
nabíjateľná a cestovná

Inovácia ľahko produktu spočíva v ovládacíj rukoväti, ktorá je možné prispôbiť podľa potreby používateľa. Vďaka jej polohovateľnosti poskytuje väčší komfort pri manipulácii a umožňuje jednoduchší a prirodzenejší pohyb počas úpravy vlasov. Styling sa tak stáva pohodlnejší a presnejší.



# stroi



- 210.2°C
- 180°C
- 200°C
- 230°C

Inovácia ľahko produktu spočíva v ovládacíj rukoväti, ktorá je možné prispôbiť podľa potreby používateľa. Vďaka jej polohovateľnosti poskytuje väčší komfort pri manipulácii a umožňuje jednoduchší a prirodzenejší pohyb počas úpravy vlasov. Styling sa tak stáva pohodlnejší a presnejší.

# 9

PROMO MATERIÁLY

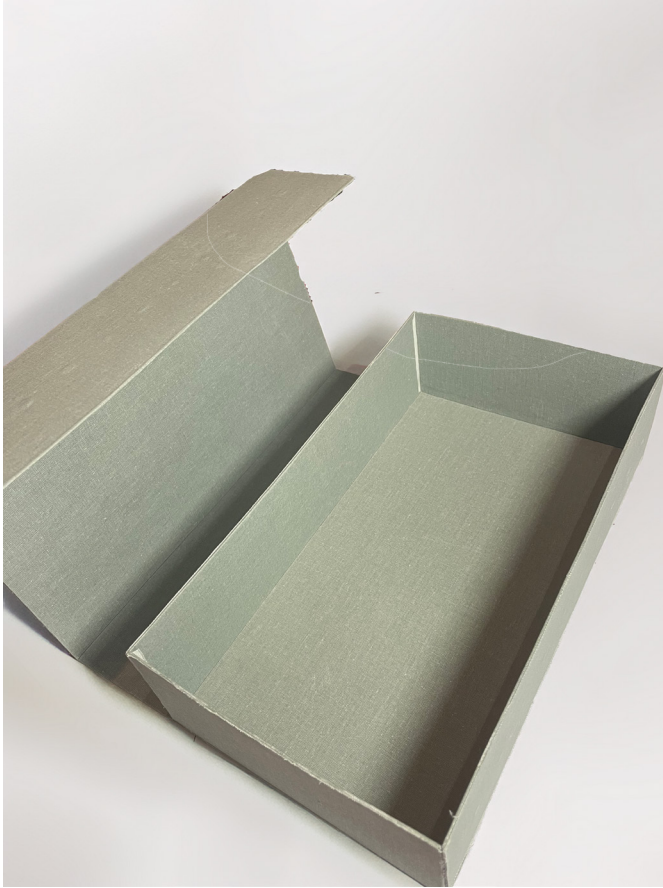



ĎAKUJEM

