

# NA TELO

K.Kalinčáková 4.B, GPD



# NÁVRHOVÁ ČASŤ

- inšpirácia
- návrhy
- finalizácia

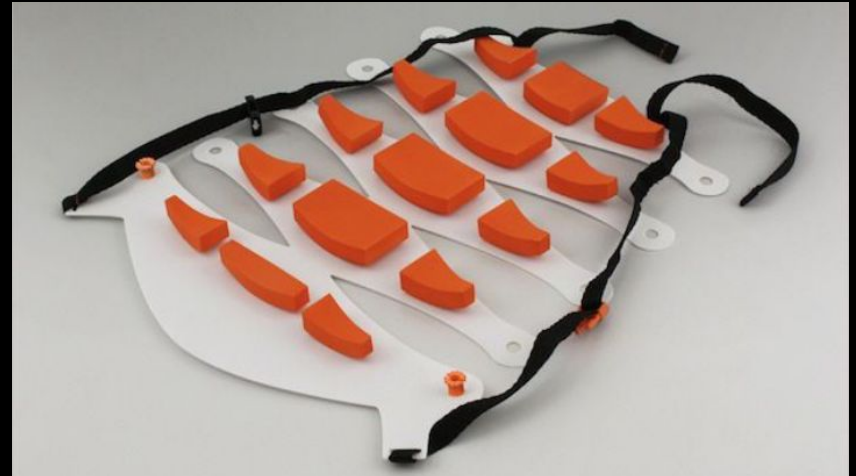

## Full body protectors -type 2

- all components  
compatible  
from all sides

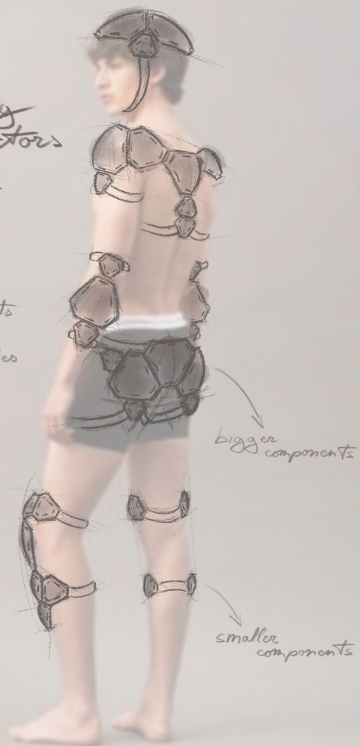

## modifiable helmet

parts for:

- cycling
- snowboarding
- skiing
- bike riding
- sports
- motocross

detachable  
parts



pendant  
+ perfume  
-type 2



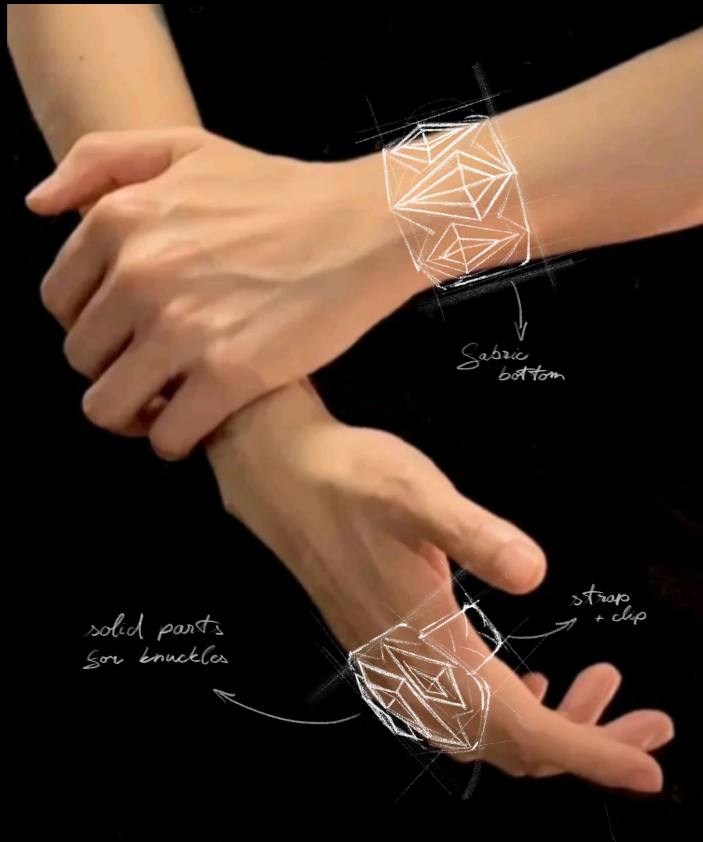

bracelet / knuckle protector  
- type 1

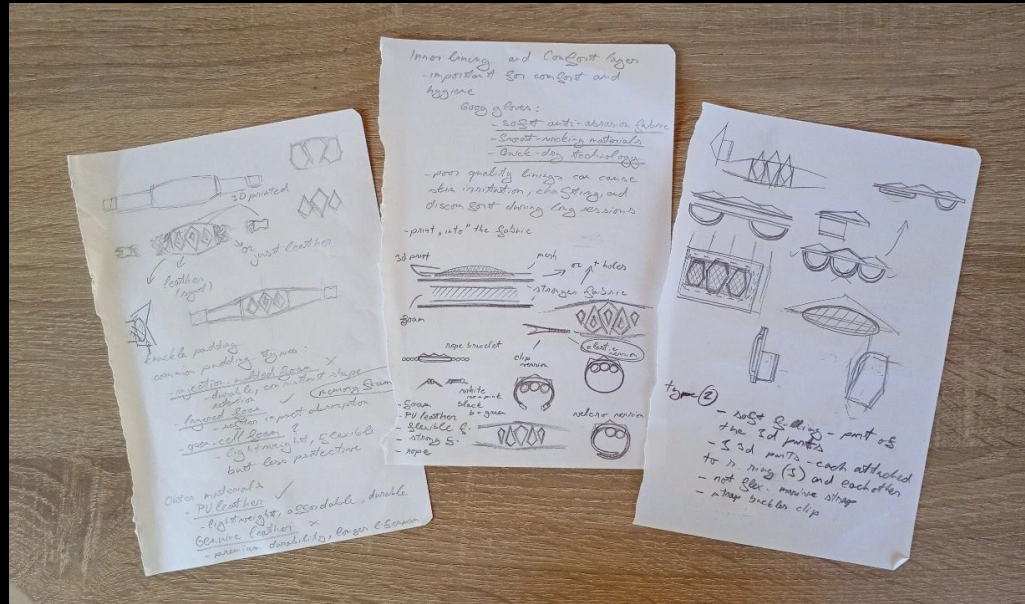

# REALIZÁCIA

- 3D modelovanie
- materiálové skúšky
- lepenie, šitie

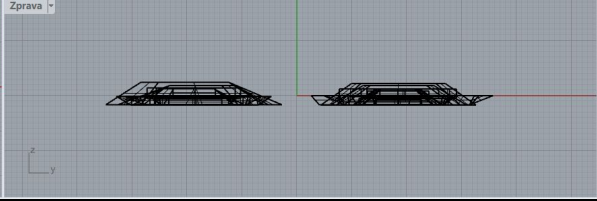
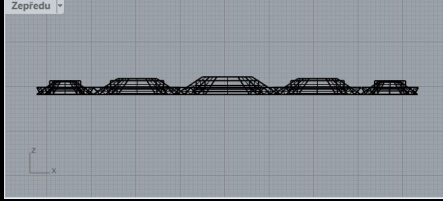
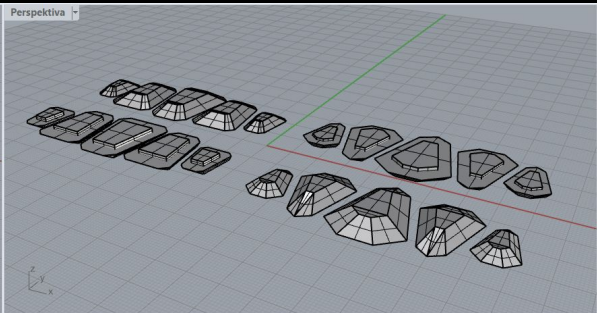
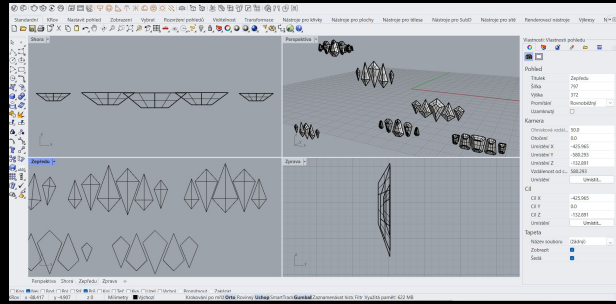
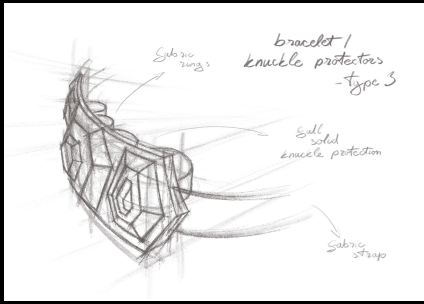





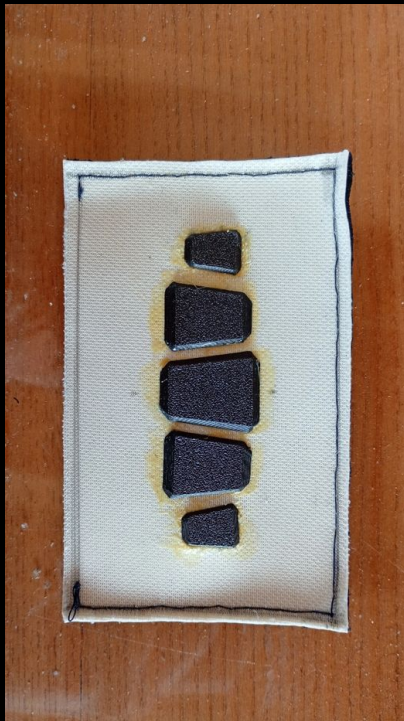

# GRAFICKÝ MATERIÁL

- technický výkres
- fotografia/vizualizácie
- postery

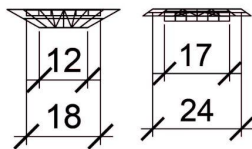
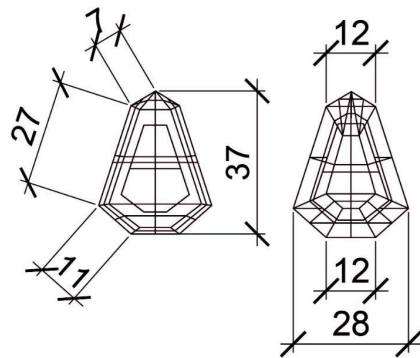
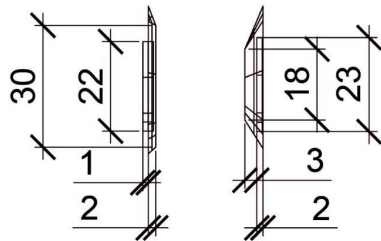

METODA ZOBRAZOVANIA	MIERKA	2:1	SVIACE					
			ZNAKA					
POZNÁMKA	VŠEOBECNÉ TOLERANCIE		ČÍSLO VÝKRESU ZOSTAVY					
			ČÍSLO SÚPSHU POLOŽIEK					
MATERIÁL	TEXTIL, KOV, FILAMENT		SÚKROMNÁ ŠKOLA UMELECKÉHO PRIEMYSLU ŽILINA					
ROZMER			NÁZOV					
HR. LHMOTNOSŤ			AEGIS					
STUŽIČKA SKUPINA	4.B		VYPRACOVÁVA					
VYPRACOVÁVA	KRISTÍNA KALINČÁKOVÁ		ČÍSLO VÝKRESU					
PREKONTROLOVAL			AEG-1-8603 M					
DÁTUM VYKOTOVENIA	3.3.2026		ROZMER VÝKR. LISTU					
			ISO-A3					





# AEGIS

designed to wear, built to defend



# AEGIS

designed to wear, built to defend

**END**